

Plasteel Composite® Double Wall Tank

**6,000 GALLONS CAPACITY
22,800 LITERS**

EMPTY WEIGHT ~ 7,800 LBS / 3,500 KILOGRAM

1. TANK MUST BE UL LISTED AND LABELED COMPOSITE PER UL STANDARDS 58 AND 1746, PART II.
2. TANK MUST BE INSTALLED PER THE PLASTEEL® TANK MANUFACTURER'S INSTALLATION INSTRUCTIONS.
3. TANK MUST COMPLY WITH THE REQUIREMENTS OF THE AUTHORITY HAVING JURISDICTION.
4. WEIGHTS AND DIMENSIONS ARE APPROXIMATE. CONSULT WITH YOUR PLASTEEL® TANK MANUFACTURER FOR SPECIFIC WEIGHTS AND DIMENSIONS.
5. THREADED CONNECTIONS ARE TYPICAL. PIPING CONTAINMENT SUMP ATTACHMENT COLLARS ARE OPTIONAL. CONSULT WITH YOUR PLASTEEL® TANK MANUFACTURER FOR DETAILS AND OPTIONS.
6. TANK VENT FITTING SIZE MUST COMPLY WITH UL STANDARD 58.

FITTING SCHEDULE		
MARK	DIM	DESCRIPTION
A	2"	NPT FITTING W/ 2" SCH 40 MONITOR ACCESS TUBE
F _f	4"	NPT FILL
F _v	2"	NPT VENT
F _o	4"	OPTIONAL NPT FITTING
F _a	4"	NPT AUTOMATIC TANK GAGE
T	4"	NPT SUBMERSIBLE TURBINE PUMP
UL	2"X3"	UL COMPOSITE SECONDARY CONTAINMENT LABEL

TYPICAL SUMP
TAB STOPS 3
EACH @ 120"

SELECTED FITTINGS
FROM ABOVE TABLE

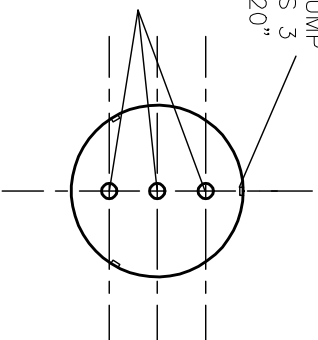

TOP VIEW
(TYPICAL COLLAR)

PLASTEEL
INTERNATIONAL INC.

2541 STATE STREET, SUITE #206

PHONE: 1-700-729-1083

FAX 1-700-729-1086

CARLSBAD, CA 92008

SCALE: NONE

APPROVED BY:

DRAWN BY:

DATE: 1-24-07

TYPICAL 6,000 GALLON

PLASTEEL COMPOSITE® DOUBLE WALL TANK